

DURACELL®

DURALOCK
POWER PRESERVE™



PLUS POWER

MN1604

Size: 9V (6LF22)

Alkaline-Manganese Dioxide Battery

Zn/MnO₂



Nominal voltage	9 V
Impedance	3,050 m-ohm @ 1 kHz
Typical weight	45 g (1.6 oz)
Typical volume	22.8 cm ³ (1.4 in ³)
Terminals	Miniature snap
Storage temperature range	5°C to 30°C (41°F to 86°F)
Operating temperature range	-20°C to 54°C (-4°F to 130°F)
Designation	IEC: 6LF22

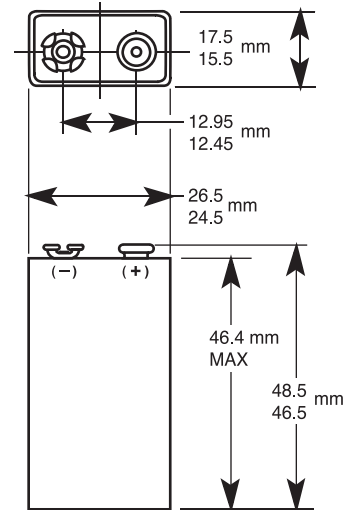

Dimensions shown are IEC standards

Plus Power 9V Constant Current

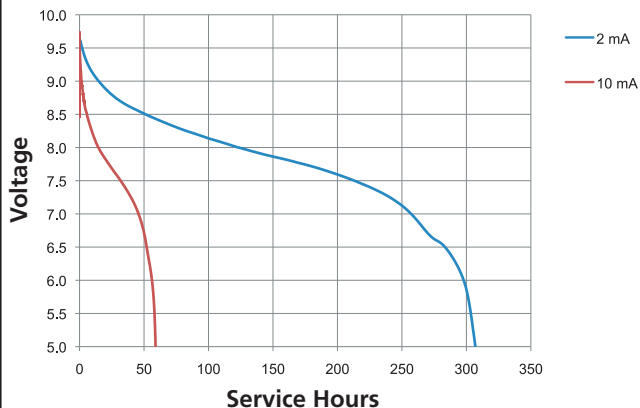

Plus Power 9V Constant Current

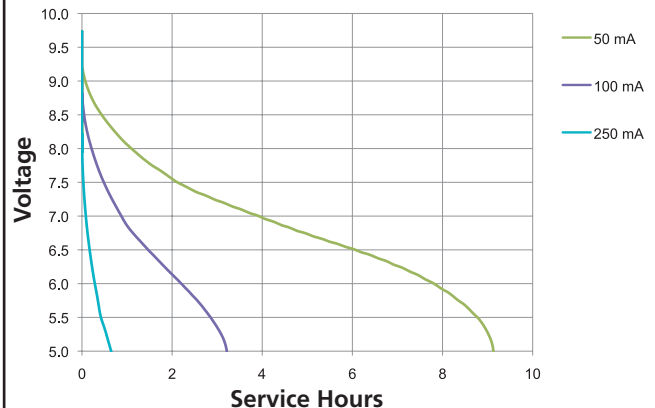

DURACELL®

BATTERIES

Berkshire Corporate Park
Bethel, CT. 06801 U.S.A.
Telephone: Toll-free 1-800-544-5454
www.duracell.com

Delivered capacity is dependent on the applied load, operating temperature and cut-off voltage. Please refer to the charts and discharge data shown for examples of the energy/service life that the battery will provide for various load conditions.

DURACELL®



PLUS POWER

MN1604

Size: 9V (6LF22)

Alkaline-Manganese Dioxide Battery

Zn/MnO₂

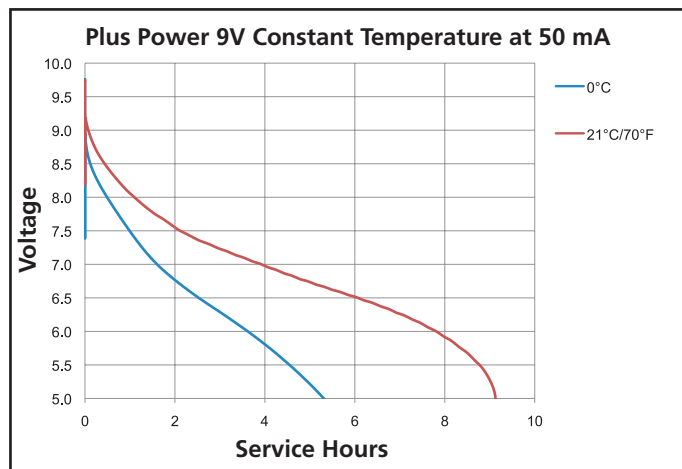
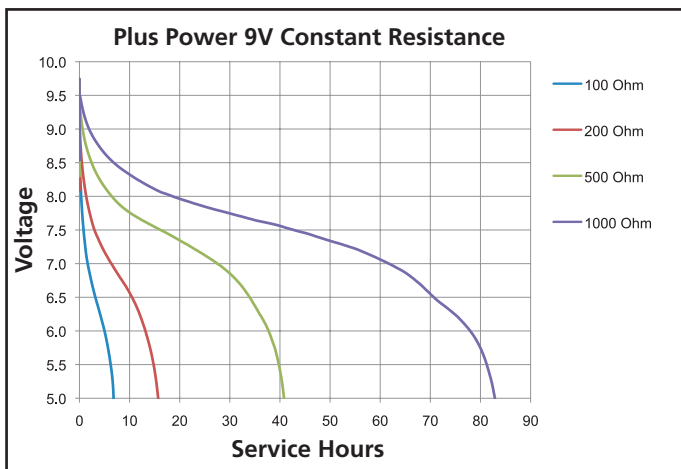
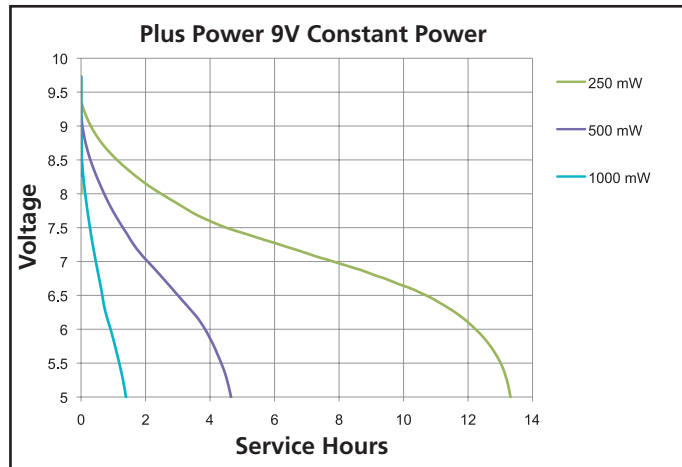
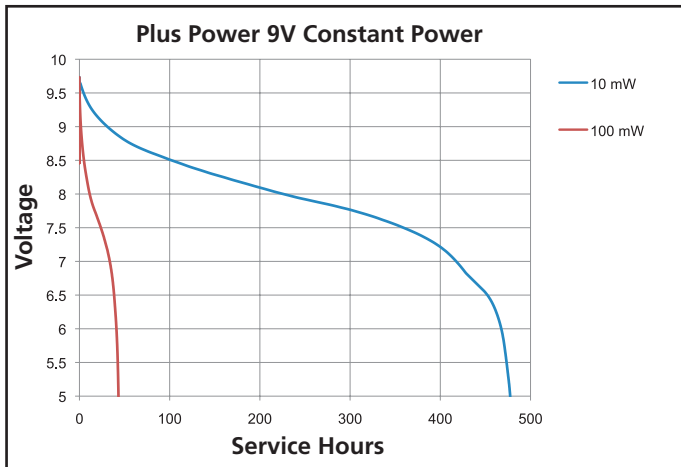

DURACELL®

BATTERIES

Berkshire Corporate Park
Bethel, CT. 06801 U.S.A.
Telephone: Toll-free 1-800-544-5454
www.duracell.com

Delivered capacity is dependent on the applied load, operating temperature and cut-off voltage. Please refer to the charts and discharge data shown for examples of the energy/service life that the battery will provide for various load conditions.